

ROASTER 

MANUAL

ROASTER WOOD/CHARCOAL CHICKEN ROTISSERIE

By BLOKAN G.P.



**PLEASE READ ALL THE INSTRUCTIONS IN THIS MANUAL
THOROUGHLY BEFORE INSTALLING AND OPERATING THE
ROTISSERIE.**

RETAIN IT FOR FUTURE REFERENCE.

IMPORTANT

The present manual will help you use the product safely.

- Read all instructions before installing and using the equipment.
- Save these instructions.
- Keep the manual within reach for future reference.
- The pictures, technical drawings and general information in this manual might have been modified since its first edition.

When this rotisserie is not properly installed, a fire may result. To reduce risk of fire, follow the installation instructions.

Please read this manual carefully before you install the rotisserie.

Failure to follow instructions may result in property damage, body injury or death.

ROASTER 

BIOKAN

Since 1988
KOZANI, GREECE

WELCOME TO BLOKAN G.P.

Our company, BLOKAN G.P. was founded in 1988 and is headquartered in Kozani, Greece. Since then, we have been manufacturing stainless steel constructions for restaurants and other food service establishments.

Over the past few years, we have specialized in manufacturing commercial kitchen exhaust hoods, charcoal ovens and rotisseries with great success. What led us to this success is the know-how and our experienced staff as well as our avant-garde machinery. We boast one of the most technologically advanced production lines of stainless-steel constructions in Greece.

As a result, we manufacture high quality products, which combine modern design with functionality, to the most competitive prices.

We manufacture and offer to our clients a large product line of stainless-steel commercial kitchen equipment, such as exhaust hoods, charcoal ovens, wood/gas pizza ovens, charcoal rotisseries and grills. We also offer consulting services, regarding the exhaust hood installation and the space disposal of the professional equipment in commercial kitchens.

BLOKAN believes in continuous improvement. Our engineers are constantly developing and redesigning products so that they can respond to our customers' needs. BLOKAN strives to construct products that are more efficient, easier to install and maintain, and products that meet the highest standards.

Our Vision is to continue being a customer centric business which has determined our development, commercial expansion, and strategy since our foundation and to keep providing our clients with high quality products and services to fair prices.

As a result, we have established long-term and fruitful business relations with the companies we have cooperated for the past few years. We always offer to our clients the best pre-sales and after - sales support.

CONTENTS

1. BEFORE USING THE ROTISSERIE

1.1. BEFORE USING THE ROTISSERIE	5
--	---

2. ROASTER ROTISSERIES MODELS

2.1 CHICKEN ROTISSERIE MODELS	7
2.2 CFW16	8
2.3 CFW12	9
2.4 CFWM16.....	10
2.5 CFWM12.....	11
2.6 Drawings	12

3. COMPONENTS

3.1 Components	14
3.2 External parts	16
3.3 Internal parts	17
3.4 Cooking Accessories	18

4. INSTALLATION INSTRUCTIONS

4.1 Warnings	19
4.2 Assembly	20
4.3 Rotisserie Fire-up	21

5. CLEANING AND MAINTENANCE

5.1 Cleaning	22
5.2 Maintenance.....	23
5.2.1 Instructions	24

6. WARRANTY

6.1 Warranty	25
--------------------	----

7. CONTACT DETAILS

7.1 Contact Details	26
---------------------------	----

1.1 BEFORE USING THE ROTISSERIE



Place the rotisserie on a hard level, non-combustible, stable surface (concrete, ground, etc.), which can support the weight of the rotisserie. Never place the rotisserie on wooden or other combustible surfaces.



The rotisserie is hot when in use. To avoid burns wear protective gloves or oven mitts.



DO NOT touch any surface of the rotisserie, as the surfaces are at high temperature.



DO NOT attempt to move the rotisserie when it is in use. Do NOT clean the rotisserie while it is still hot.



Place the rotisserie on a surface which is NOT accessible to children and pets. Close supervision is necessary when the rotisserie is in use.



Never leave burning charcoal/wood or ashes in rotisserie unattended. Before the rotisserie can be left unattended, the remaining charcoal/wood and the ashes must be removed. Do NOT pour ashes into flammable or thermo deformable buckets made from materials like plastic, rubber, wood or similar.



Store the unit in a safe and dry place. Rain or adverse weather conditions may damage the rotisserie.

1.1 BEFORE USING THE ROTISSERIE



Do NOT put off the fire by throwing water in the rotisserie.



Do NOT throw the charcoal or wood into the rotisserie but place them gently.



DO NOT store lighter fluid and other flammable liquids or materials under the rotisserie. Put any flammable material at least 30 cm away from the sides or the top of the rotisserie.



DO NOT use gasoline, kerosene or alcohol to fire up the charcoal/wood. Using any of these or similar products could cause an explosion and possibly lead to severe injury.



DO NOT install this appliance in any area where it may be affected by any adverse conditions such as steam, grease, dripping water, high temperatures, or any other adverse conditions.



Respect the frequency and guidelines of maintenance and cleaning recommended by BOKAN G.P. in this manual.



When this equipment is not properly installed, a fire may result. To reduce risk of fire, follow the installation instructions.



BOKAN G.P. will not be responsible of any damages caused to people, parts or installations due to improper use or maintenance of the rotisserie.



The legislation of the country and town, where the equipment is going to be installed, must be checked since norms and regulations may ask for further safety measures than the ones exposed in this manual.

2.1 ROTISSERIE MODELS



CFW16 Capacity 36-42 chickens
Six spit rods



CFW12 Capacity 18-24 chickens
Six spit rods

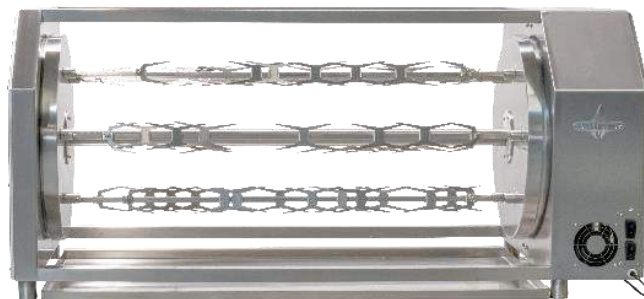

CFWM16 Capacity 36-42 chickens
Six spit rods

CFWM12 Capacity 22-30 chickens
Six spit rods

TECHNICAL INFORMATION

Roasting area	1200 mm x 6 spit rods
Maximum capacity	42 chickens
Fire up time	30 min average
Charcoal/Wood daily consumption *	Charcoal 32 – 36 kg
Broiling temperature	200 °C a 300 °C
Maximum weight per spit rod	10 – 12 Kg
Exhaust rate	4.000 m3/h
Net weight	550 kg
Electric connection	EU: 220 V / 50 Hz USA: 120 V / 60 Hz

INSTALLATION

Clearance with non-flammable equipment	100 mm
Clearance with flammable equipment	300 mm

INCLUDED

- 6 Spit rods
- 30 double spit forks for chickens
- 12 single spit forks for chickens
- 2 side loading door
- Grease Collector
- Evacuation tap
- Poker
- Fire Bricks
- Packaging

OPTIONAL

- Flat Basket CGA14
- Double Spit CGA15
- Round Basket CGA16
- Planetary system 15 spits
- Grease Collector
- 2 side charcoal loading door
- Rod Spit
- Single Spit Fork
- Double Spit Fork
- Poker

*The charcoal or wood quantity you are going to use depends on the charcoal or briquette quality.

2.3 CFW12

TECHNICAL INFORMATION

Roasting area	760 mm x 6 spit rods
Maximum capacity	30 chickens
Fire up time	30 min average
Charcoal/Wood daily consumption *	Charcoal 18 – 22 Kg
Broiling temperature	200 °C a 300 °C
Maximum weight per spit rod	10 – 12 Kg
Exhaust rate	3.000 m3/h
Net weight	450 kg
Electric connection	EU: 220 V / 50 Hz USA: 120 V / 60 Hz

INSTALLATION

Clearance with non-flammable equipment	100 mm
Clearance with flammable equipment	300 mm

INCLUDED

- 6 Spit rods
- 18 double spit forks for chickens
- 12 single spit forks for chickens
- 2 side charcoal loading door
- Grease Collector
- Evacuation tap Poker
- Fire Bricks
- Packaging

OPTIONAL

- Flat Basket CGA14
- Double Spit CGA15
- Round Basket CGA16
- Planetary system 15 spits
- Grease Collector
- 2 side charcoal loading door
- Rod Spit
- Single Spit Fork
- Double Spit Fork
- Poker

*The charcoal or wood quantity you are going to use depends on the charcoal or briquette quality.

TECHNICAL INFORMATION

Roasting area	1125 mm X 6 spit rods
Maximum capacity	42 chickens
Fire up time	30 min average
Charcoal daily consumption *	Charcoal 25 – 30 kg
Broiling temperature	200 °C a 300 °C
Maximum weight per spit rod	10 – 12 Kg
Exhaust rate	4.500 m3/h
Electric connection	EU: 220 V / 50 Hz USA: 120 V / 60 Hz
Net weight:	250 kg

INSTALLATION

Clearance with non-flammable equipment	100 mm
Clearance with flammable equipment	300 mm

INCLUDED

- 6 Spit rods
- 30 double spit forks for chickens
- 12 single spit forks for chickens
- Poker
- Packaging

OPTIONAL ACCESORIES

- Rod Spit
- Single Spit Fork
- Double Spit Fork
- Poker

*The charcoal or wood quantity you are going to use depends on the charcoal or briquette quality.

TECHNICAL INFORMATION

Roasting area	675 mm X 6 spit rods
Maximum capacity	30 chickens
Fire up time	30 min average
Charcoal daily consumption *	Charcoal 18 – 22 kg
Broiling temperature	200 °C a 300 °C
Maximum weight per spit rod	10 – 12 Kg
Exhaust rate	3.000 m3/h
Electric connection	EU: 220 V / 50 Hz USA: 120 V / 60 Hz
Net weight:	200 kg

INSTALLATION

Clearance with non-flammable equipment	100 mm
Clearance with flammable equipment	300 mm

INCLUDED ACCESSORIES

- 6 Spit rods
- 18 double spit forks for chickens
- 12 single spit forks for chickens
- Poker
- Packaging

OPTIONAL ACCESSORIES

- Rod Spit
- Single Spit Fork
- Double Spit Fork
- Poker

*The charcoal or wood quantity you are going to use depends on the charcoal or briquette quality

2.6 DRAWINGS

DIMENSIONS (mm): CFW16

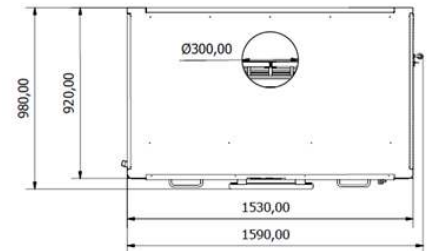
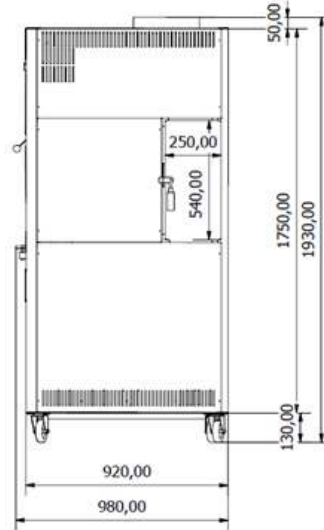
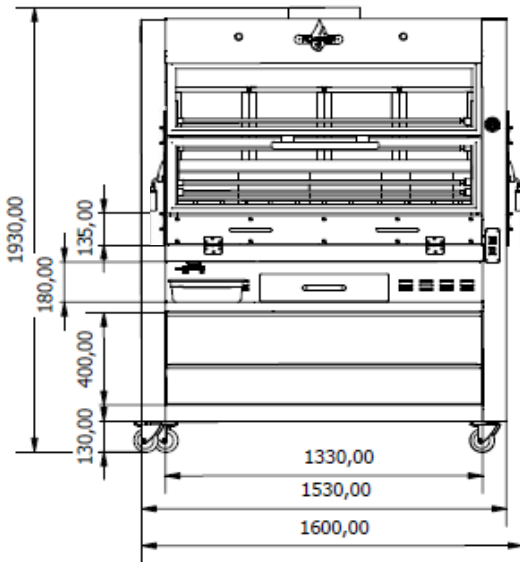

CFW12

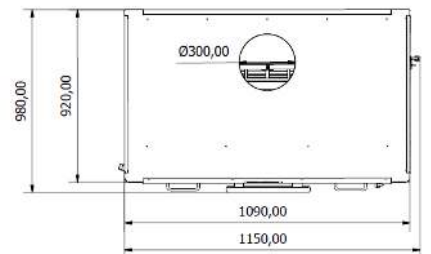
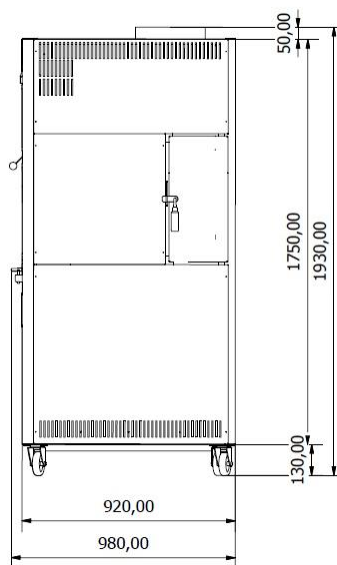
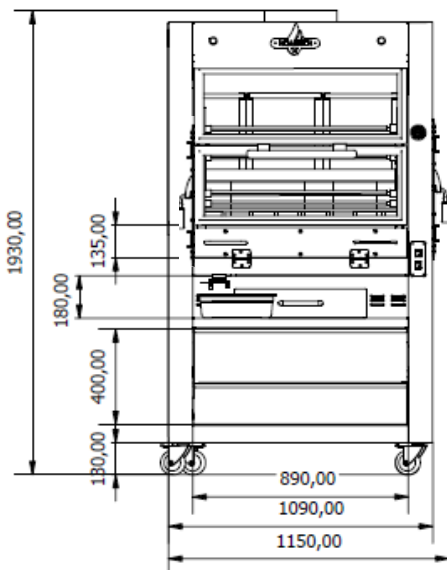

2.6 DRAWINGS

Dimensions (mm) Built-in version:

CFWM16

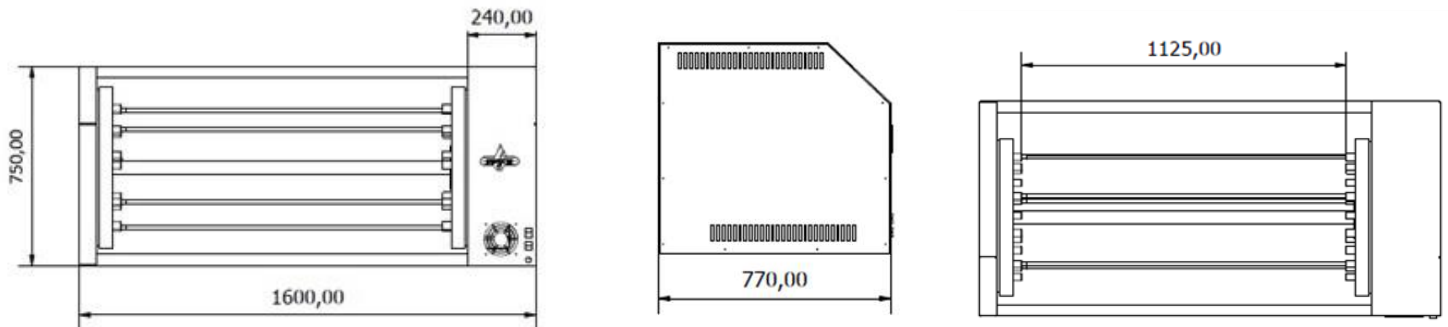

CFWM12

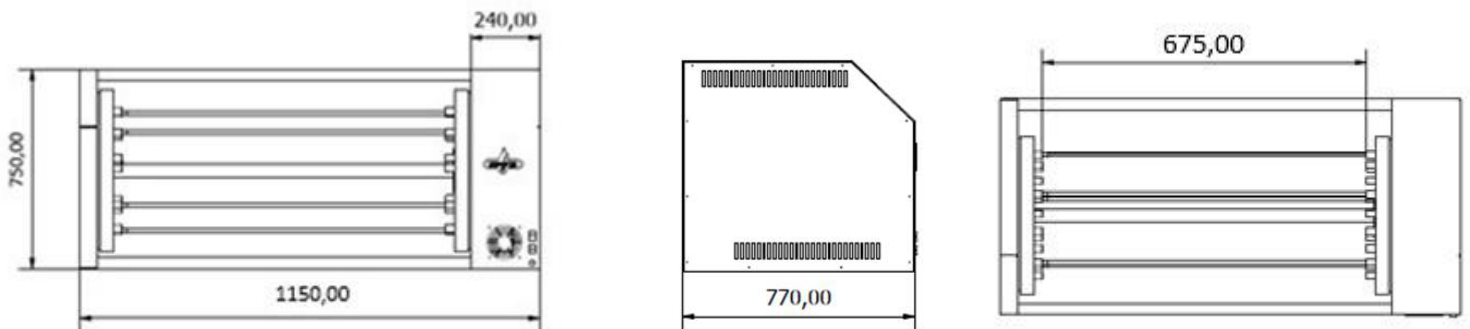



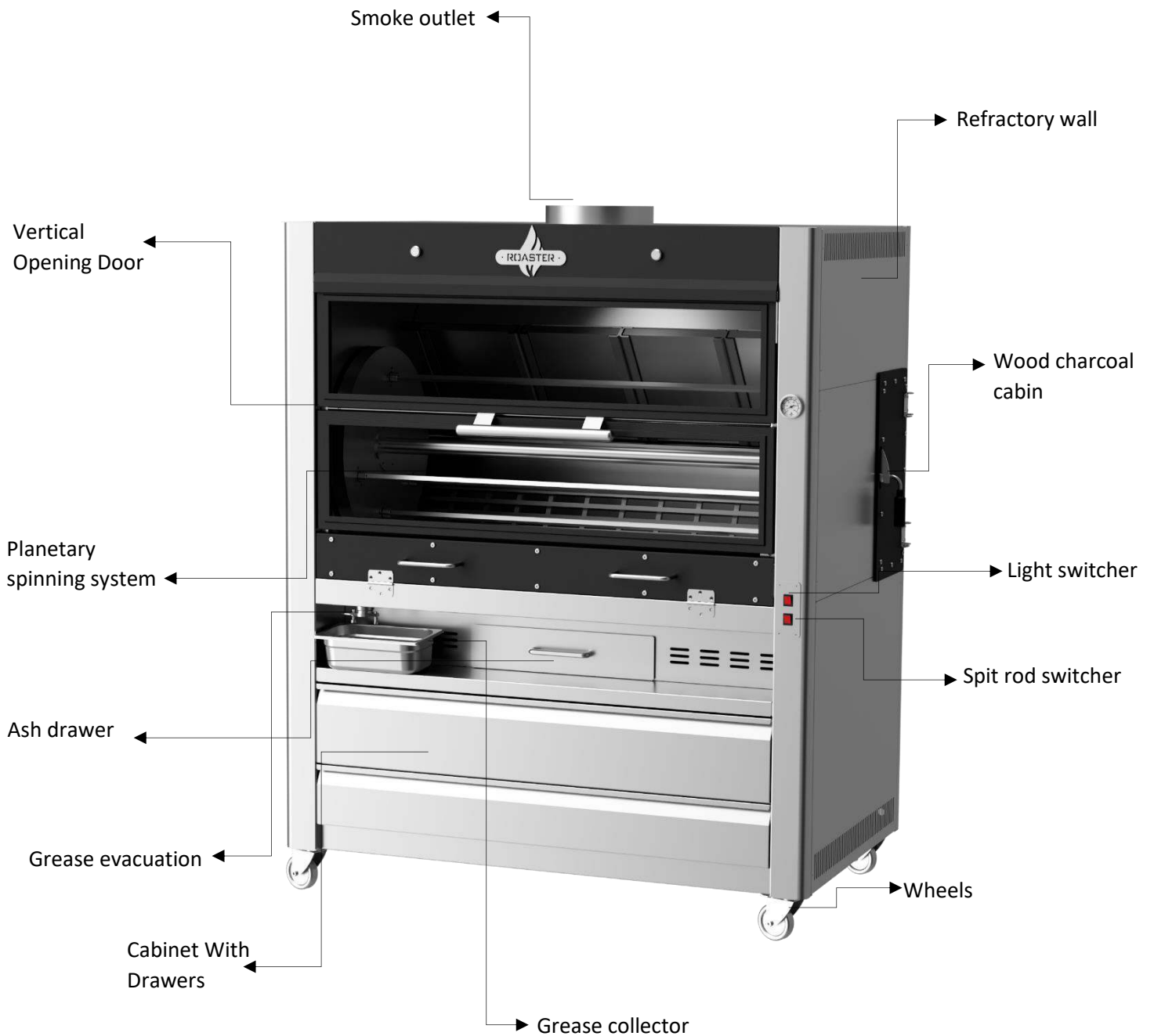

3.1 COMPONENTS

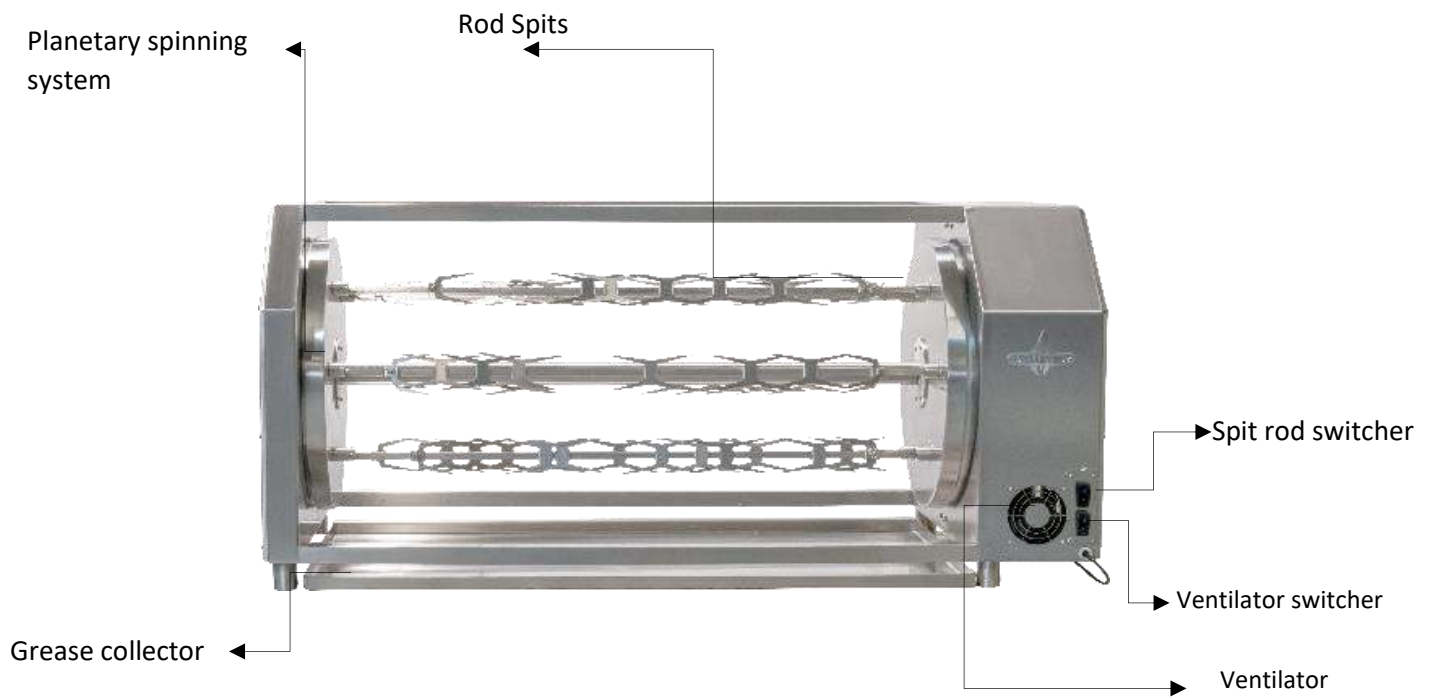

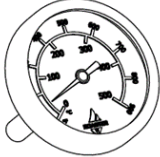

3.1 COMPONENTS

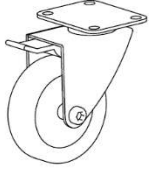
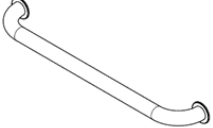

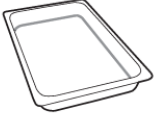



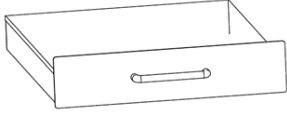
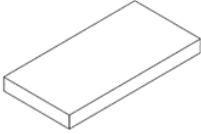
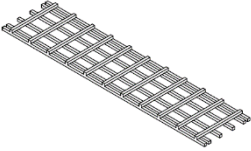

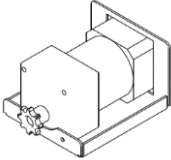
3.2 EXTERNAL COMPONENTS

IMAGE	DESCRIPTION	CODE
	Thermometer up to 500°	CT1
	Grease Evacuation Tap	CGA20
	Wheels	CGA12
	Door Handle	RDH2
	Ash Drawer	RGT1
	Grease collector	

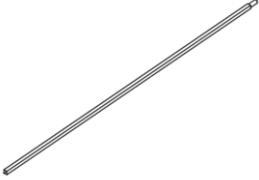
3.3 INTERNAL COMPONENTS

IMAGE	DESCRIPTION	CODE
	Ash Pan Drawer	RAPD1
	Refractory Brick Wall	RFRW
	Charcoal/ Wood holder	RCWH
	High temperature lamp 40Watt	CRHTL
	Motor 220V/60Watt	CRMTR

3.4 COOKING ACCESSORIES

IMAGE	DESCRIPTION	CODE
	Rod Spit	CFWRS12 CFWRS16
	Single Spit Fork	CGA10
	Double Spit Fork	CGA11
	Cooking basket flat	CGA14 CGA14B
	Double Spit	CGA15 CGA15B
	Cooking basket round	CGA16 CGA16B
	Poker	POK

4.1 WARNINGS



Before fire-up the rotisserie for the first time, remember to remove all the protective film that is covering the exterior of the rotisserie.



This product may have been dispatched in more than one packages. Check that all items and accessories have been received as ordered. Keep all instructions/manuals.



Do NOT use flammable liquids to fire-up the charcoal or wood. Only use charcoal or wood as fuel for the rotisserie.



DO NOT place any obstructions that may block the access for the maintenance or the service of the rotisserie. DO NOT block the lateral and inferior part of the rotisserie, as the motor can be seriously damaged, due to limited air circulation. DO NOT modify or damage the feet or the wheels of the rotisserie.



We recommend that you always place the rotisserie under an exhaust hood.



In all the installation options, it is important to keep the components of the hood clean (see Chapter 5, Cleaning and maintenance).



The diameter of the extraction tube must be at least 300 mm for all the models.



You must fire-up the rotisserie before starting roasting. All the firing-up process must be done without any accessories inside the rotisserie.



Place the rotisserie at a distance of at least 100 mm away from the wall or any other cooking appliance.

4.2 ASSEMBLY

a.

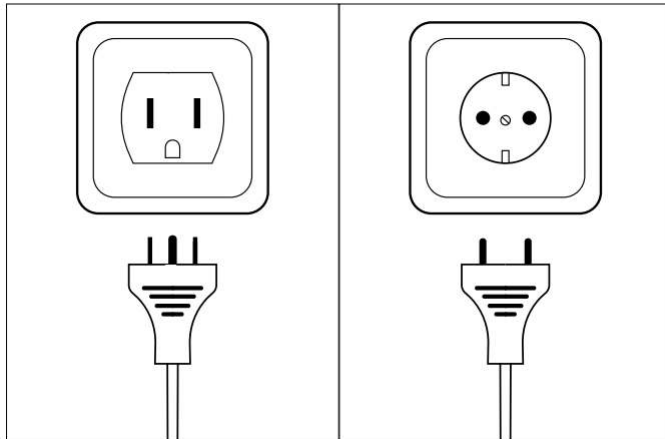

Plug the rotisserie into an outlet with the following specifications:

USA: 120V / 60Hz

EU: 220V / 50Hz

b.

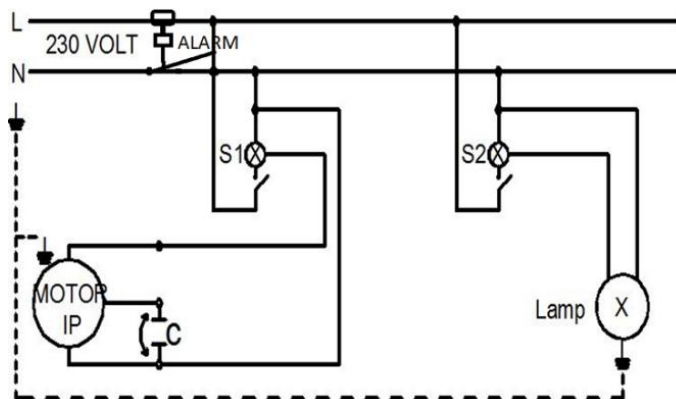

Electrical Drawing:

The rotisserie must be properly grounded in accordance with the European Union Standards.

c. Turn on or off the rotisserie by pressing the ON/OFF button.

4.3 ROTISSERIE FIRE – UP

INSTRUCTIONS:

- Use solid charcoal/wood fuel only.
- Do NOT place the charcoal inside the ash drawer.
- Open the rotisserie lateral door and load the charcoal/wood.
- Place the charcoal/wood in the fire basket and place the firelighters at at least three different spots.
- Wait until the charcoal has acquired a reddish color (35 minutes approximately).
- Put the spit rods or accessories in, as the rotisserie is ready to operate.



Cooking temperature 150 °C to 250 °C



Do not put out the rotisserie by using water or other liquids.

Charcoal will be consumed itself.



Always fill the grease collector with water.

- The quantity of charcoal required depends on which Rotisserie model you are using

Model	CWF16	CWF12
Maximum charcoal quantity	15 kg*	8 kg*
Chicken capacity	42	24

**The charcoal or wood quantity you are going to use depends on the charcoal or wood quality.*

5.1 CLEANING

WARNINGS



Perform the operations when the rotisserie is cold to avoid burns.



Do NOT use chemical products to clean the rotisserie.



Do NOT pour ashes into flammable or thermo deformable recipients made from materials like plastic, rubber, wood or similar.



CAUTION! DO NOT splash water directly into the rotisserie and DO NOT use any water or any kind of liquid, as this could cause an electric shock.



Clean with a grease remover and a cloth or brush.

- It is necessary to clean spit rods and the other roasting accessories after every use.
- Remove the grease tray and wash it with a grease remover and a brush or cloth.
- Do NOT use a corrosive grease remover to clean the outside of the rotisserie or/and the inside of the cabinet below.
- Clean the door of the rotisserie with a grease remover and a cloth.
- Remove the ash drawer and clean it with a grease remover and a brush.
CAUTION! Ashes must be placed in a metal container which should be placed on a non-combustible surface or on the ground, away from combustible materials, until their final disposal.
- The grates of the fire pit should be cleaned once or twice a week with a wire brush. **CAUTION!** DO NOT use water.

5.2 MAINTENANCE



Make sure that the rotisserie is cold before performing any maintenance operation.



Wear protective gloves or oven mitts.



It is forbidden to perform any modification to the equipment unless it has been approved by BIOKAN Inc. before.



Do NOT use pieces or parts of other companies.



BIOKAN G.P. will not be responsible of damages provoked to people, parts or installations caused by an improper use or maintenance of the rotisserie.



All inspections must be carried out by qualified personnel.

5.2.1 INSTRUCTIONS

- **Grease the gears twice a year.**

Put on protective gloves.

Switch off and plug out the rotisserie.

Unscrew the bolts laterally to have access to the rotating system.

Pull the housing gently and remove it.

Grease the gears with a special temperature grease. Then turn on the rotisserie by using the switcher and after a few seconds turn it off. Grease the part of the gears that was not accessible before.

- **Light bulb replacement.**

Put on protective gloves.

Open the rotisserie door.

Unscrew manually the fireproof glass bulb and replace the lamp inside.

Screw the fireproof glass bulb again.

- **Refractory wall – fire bricks replacement.**

Put on protective gloves.

Open the lateral door to access the charcoal/wood cabinet.

Remove the firebricks that are blocking the exit of the brick you want to change.

- **Motor replacement.**

Put on protective gloves.

Switch off and plug out the rotisserie.

Unscrew the bolts laterally to have access to the rotating system.

Pull the housing gently and remove it.

Unscrew the old motor and replace it with the new one paying attention to all the connections.

CAUTION! It is recommended that the operations be done by qualified personnel.

- **Thermometer replacement.**

Put on protective gloves.

Switch off and plug out the rotisserie.

Unscrew the bolts laterally to have access to the rotating system.

Pull the housing gently and remove it.

Unscrew the screws that hold the thermometer at the front.

Unscrew the screws that hold the thermometer wire inside.

6.1 WARRANTY



BIOKAN G.P. guarantees ONE-year warranty from the purchase date of this product, against any defect in the materials and the components used its fabrication.

THIS WARRANTY WILL NOT BE VALID UNDER THE FOLLOWING CIRCUMSTANCES

1. When the Buyer or the End user do not follow strictly the instructions of use in this manual.
2. When the product has been misused, damaged, or exposed to any liquid or corrosive substance or for any other faults attributable to the Buyer or End user.
4. When the product has been modified or repaired by non-qualified personnel.
5. When the fault is due to the normal wearing out of the rotisserie and its parts due to long term use.
6. When the damage is caused by liquids, chemicals or products that should not be poured inside the oven.

NOTES:

- Repair or substitution is possible only when a product was originally defective (at the time of delivery).
- The Buyer or the End user is responsible for any damage caused due to wrong or improper use.
- The Buyer should inspect the products immediately after the delivery and any complaints or arguments must be sent to our company within five (5) business days.
- The risk of loss, destruction, or damage of the product during the shipping is the Buyer's or carrier's responsibility, even if the shipping order has been given by our Company upon the Buyer's request.
- All repairs during the warranty periods of 12 months, are performed in our factory in Greece.
- The Buyer is responsible for the shipping of the products and covers exclusively the shipping cost.
- If the problem to be repaired is caused by an incorrect use or installation a charge will be applied, even if the product is in the warranty period.

No other warranty, verbal or written, different than the one expressed here will be accepted by BIOKAN G.P.



CHARCOAL OVENS & GRILLS

By BIOKAN G.P.



www.roastergrills.com



sales@roastergrills.com



www.facebook.com/RoasterOvens



https://www.instagram.com/roaster_ovens



<https://www.linkedin.com/company/biokan-oe>



<https://www.youtube.com/channel/UCjOpxGWZamP7FVeQ2Dx45yA>

FACTORY

2nd km. Kozanis – Neas Nikopolis, 50100, Kozani, GREECE

Tel.: +30 2461 0 36538

HEAD OFFICES

312 Syggrou Av, Kallithea, 17673, Athens, GREECE

Tel.: +30 21 0 2203458