

## ROASTER COMBI DU-GP2GC-R56



### AVAILABLE COLORS



### ACCESSORIES

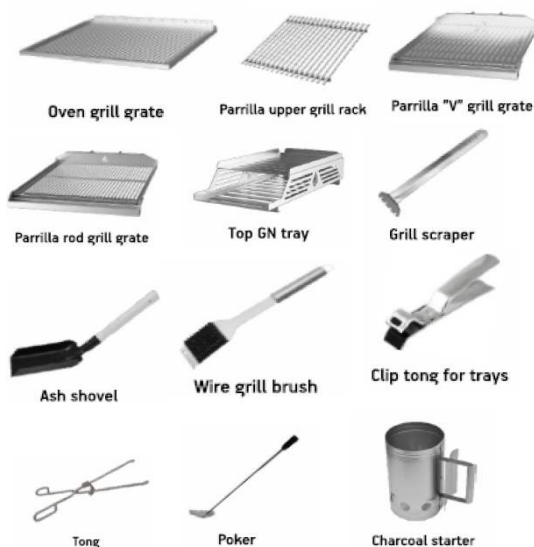

### CABINET OPTIONS



### TECHNICAL INFORMATION

Productivity	± 140 Diners
Fire up time	30 min average
Charcoal daily consumption*	Charcoal 28 – 34 kg
Broiling temperature	250°C to 350°C
Exhaust rate	4.600 m3/h

### DIMENSIONS & WEIGHTS

Dimensions (NET)	2055X825X1645 mm
Weight (NET)	597 kg

### INSTALLATION

Clearance with non-flammable equipment	100 mm
Clearance with flammable equipment	300 mm
* Depends on the charcoal quality	

### INCLUDED

Scraper	2X Parrilla "V" grill grates	Ash Collector Drawer	Grease Collector	Fire Bricks
Poker	3X Upper Grill Racks	Charcoal Shovel	Charcoal Starter	Packaging
Tong	2X Oven Grill Grates	Fire breaker	Wire Brush	Clip Tong
Thermal Protection	2X Top GN Trays			

### TECHNICAL INFORMATION ROC56

Productivity + -	95 diners
Roasting area	535X590 mm
Fire up time	30 min average
Charcoal daily consumption*	Charcoal 10 – 12 kg
Roasting temperature	250 °C to 350 °C
Exhaust rate	2.100 m3/h
Heat Output*	6 kw
Extraction diameter	180 mm
Performance	9h
Dimensions without Packaging	785X825X1645 mm
Dimensions with Packaging	930X1020X1930 mm
Net Weight	327 kg
Gross Weight	380 kg



### TECHNICAL INFORMATION GP2GC

Roasting area	1000X620 mm
Fire up time	30 min average
Charcoal daily consumption*	Charcoal 18 – 22 kg
Grilling temperature	200 °C to 250 °C
Exhaust rate	2.500 m3/h
Dimensions without Packaging	1270X825X1550 mm
Dimensions with Packaging	1420X1020X1790 mm
Net Weight	270 kg
Gross Weight	370 kg



**TECHNICAL DRAWINGS**

Front view

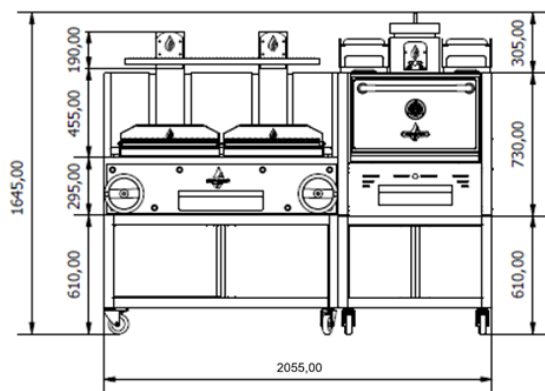

Side view

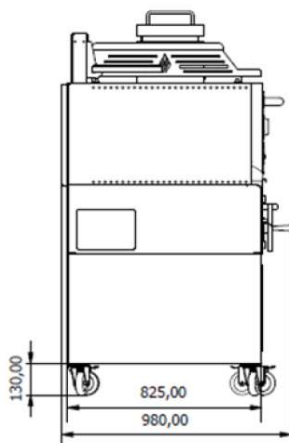

Dimensions with Open Door

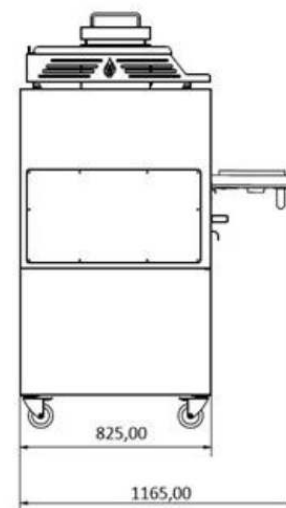

Top view

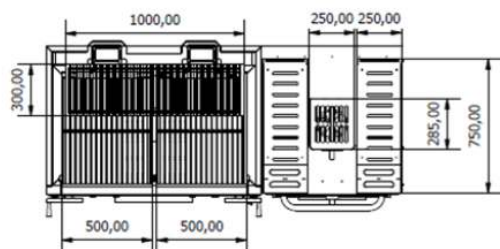

Roasting Area Oven

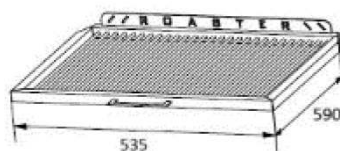

Roasting Area Parrilla

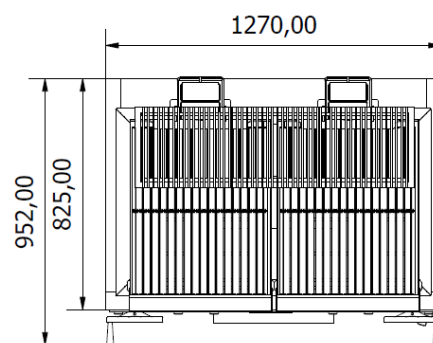

**MAIN COMPONENTS**

