

**ROASTER PARRILLA CHARCOAL GRILL
GP1G**



AVAILABLE COLORS



Black Red Blue Inox

ACCESSORIES

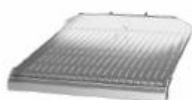

Parrilla "V" grill grate

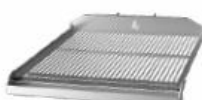

Parrilla rod grill grate



Parrilla upper grill rack



Poker



Grill scraper



Ash shovel



Charcoal starter

OPTIONAL



Frontal GN support

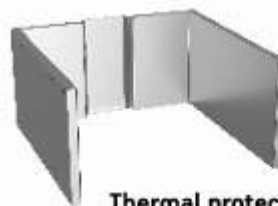

Thermal protection

TECHNICAL INFORMATION

Roasting area	630X620 mm
Fire up time	30 min average
Charcoal daily consumption*	Charcoal 16 – 20 kg
Broiling temperature	200 °C to 250 °C
Exhaust rate	2.000 m3/h

DIMENSIONS & WEIGHTS

Without packaging	800X825X1000 mm
With packaging	930X1020X1240 mm
Weight (NET)	130 kg
Weight (with packaging)	170 kg

INSTALLATION

Clearance with non-flammable equipment	100 mm
Clearance with flammable equipment	300 mm

*Depends on the charcoal quality

INCLUDED

Scrapper	1X Parrilla "V" grill grate	Ash Collector Drawer	Grease Collector	Fire Bricks
Poker	2X Upper Grill Racks	Charcoal Shovel	Charcoal Starter	Packaging



TECHNICAL DRAWINGS

Front view

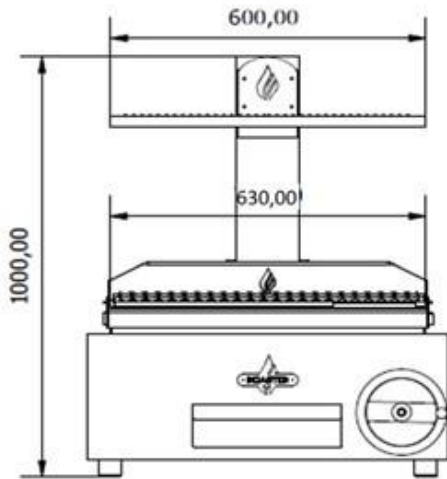

Side view

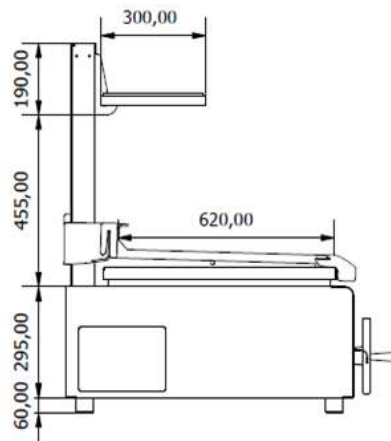

Top view

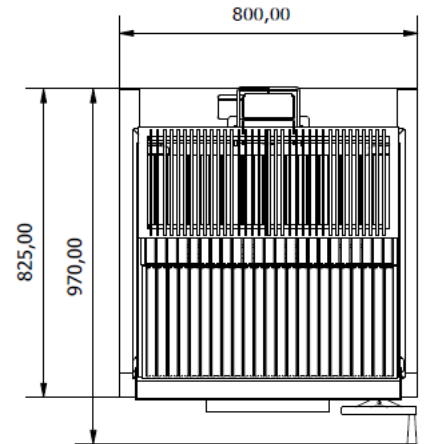

MAIN COMPONENTS

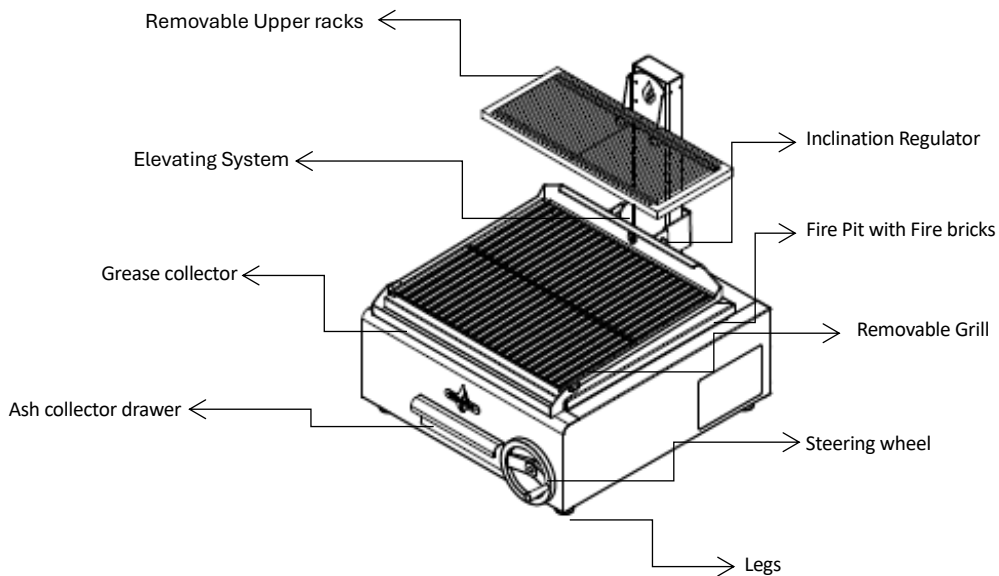

*Dimensions in mm

*The parrilla grills are subject to technical and design changes without previous notice

