

**ROASTER CHARCOAL ROBATA
GRILL GR85**



TECHNICAL INFORMATION

Roasting area	620X260 mm
Fire up time	20 min average
Charcoal daily consumption*	Charcoal 8 - 10 kg
Broiling temperature	200°C to 250°C
Exhaust rate	2.500 m3/h

DIMENSIONS & WEIGHTS

Without packaging	850X450X730 mm
With packaging	950X600X1000 mm
Weight (NET)	82 kg
Weight (with packaging)	115 kg

INSTALLATION

Clearance with non-flammable equipment	100 mm
Clearance with flammable equipment	300 mm
* Depends on the charcoal quality	

INCLUDED

Scraper	Rod grill grates	Poker	Grill Scraper
Ash shovel	Upper Grill Racks	Fire Bricks	Packaging

ACCESSORIES



OPTIONAL



Open Cabinet with one shelf



Open Cabinet with drawers,
GN supports and one shelf



Cabinet with opening doors
and GN supports



Frontal GN support



TECHNICAL DRAWINGS

Front view

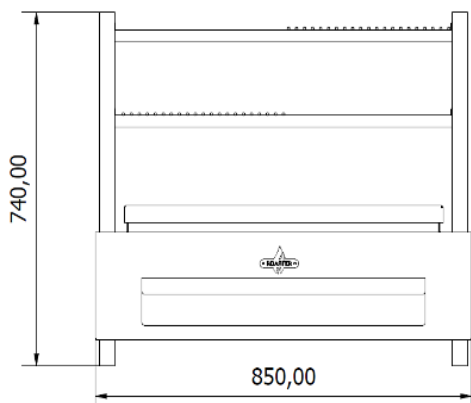

Side view

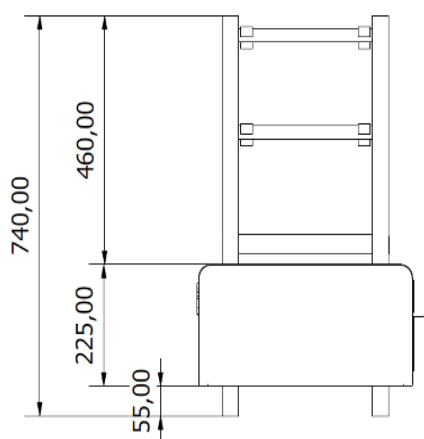

Top view

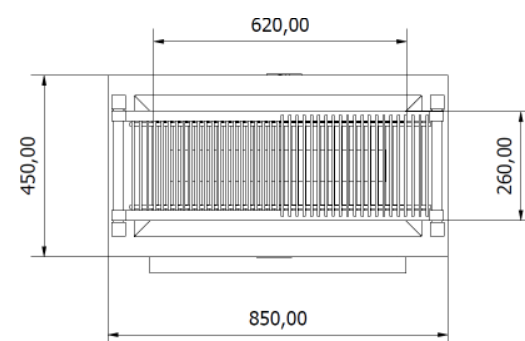

MAIN COMPONENTS

