

**ROASTER CHARCOAL CHURRASCO GRILL
K12BF**



AVAILABLE COLORS



Black Red Blue Inox

ACCESSORIES

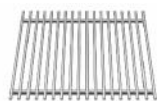

Rod grill grate



Basket



Skewers



Ash shovel



Grill scraper



Poker



Waiting stand



Charcoal starter

TECHNICAL INFORMATION

Roasting area	1330X500 mm
Maximum capacity	12 skewers// 4 baskets//4 grill racks
Fire up time	30 min average
Charcoal daily consumption*	Charcoal 16 - 24 kg
Maximum weight per skewer/basket	5 – 7 kg
Maximum capacity chickens	8
Exhaust rate	4.000 m3/h
Electric connection	EU:220 V /50 Hz USA:120 V /60 Hz

DIMENSIONS & WEIGHTS

Without packaging	1600X610X1000 mm
With packaging	1710X810X1310 mm
Weight (NET)	250 kg
Weight (with packaging)	322 kg

INSTALLATION

Clearance with non-flammable equipment	100 mm
Clearance with flammable equipment	300 mm

*Depends on the charcoal quality

INCLUDED

2X Grill grates	Poker	Charcoal Starter	Grill Scraper	3X Baskets
6 Skewers 8X8mm	Fire Bricks	Ash shovel	Waiting Stand	Packaging



TECHNICAL DRAWINGS

Front view

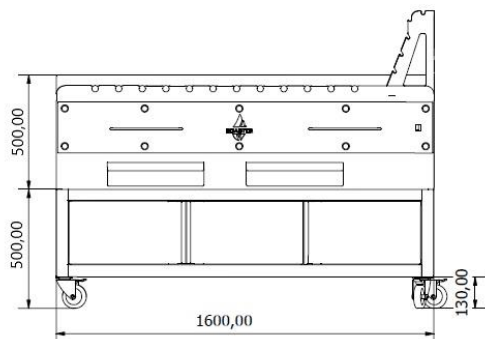

Side View

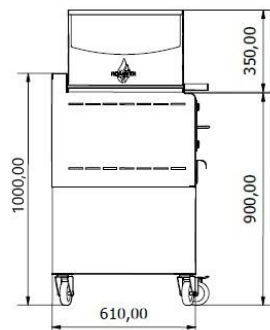

Grill grates

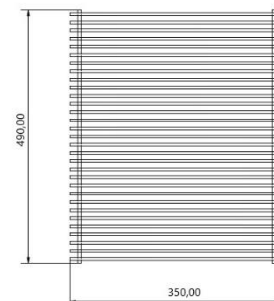

Basket Dimensions

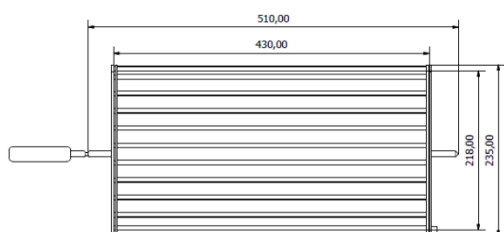

Top view

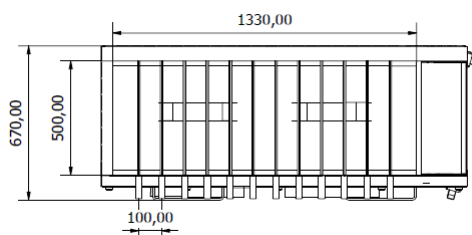

MAIN COMPONENTS

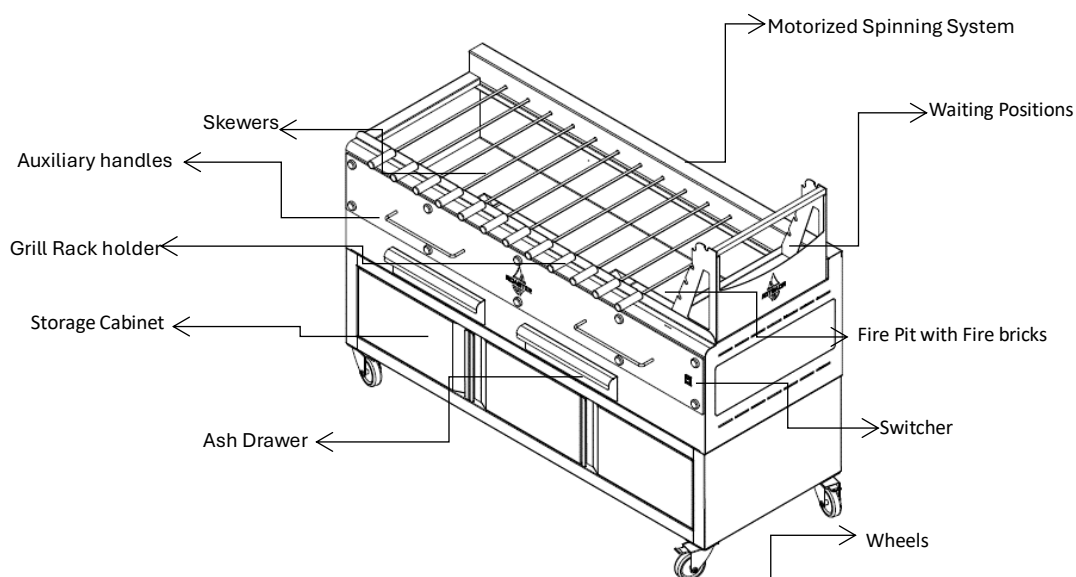

*Dimensions in mm

*The churrasco grills are subject to technical and design changes without previous notice

