

ROASTER MULTI GRILL STATION MU140



AVAILABLE COLORS



ACCESSORIES

OPTIONAL



Open Cabinet with one shelf



Open Cabinet with drawers,
GN supports and one shelf



Cabinet with opening doors
and GN supports

TECHNICAL INFORMATION

Roasting area	1140X520 mm
Fire up time	30 min average
Charcoal daily consumption*	Charcoal 21 – 25 kg
Broiling temperature	200°C to 250°C
Exhaust rate	3.500 m3/h

DIMENSIONS & WEIGHTS

Without packaging	1400X825X1550 mm
With packaging	1550X1020X1790 mm
Weight (NET)	240 kg
Weight (with packaging)	370 kg

INSTALLATION

Clearance with non-flammable equipment	100 mm
Clearance with flammable equipment	300 mm

* Depends on the charcoal quality

INCLUDED

Scraper	1X Parrilla "V" grill grates	Ash Collector Drawer	Grease Collector	Fire Bricks
Poker	2X Upper Grill Racks	Charcoal Shovel	Charcoal Starter	Packaging
Skewers	Thermal Protection	Rod Grill Grate	Grill Brush	

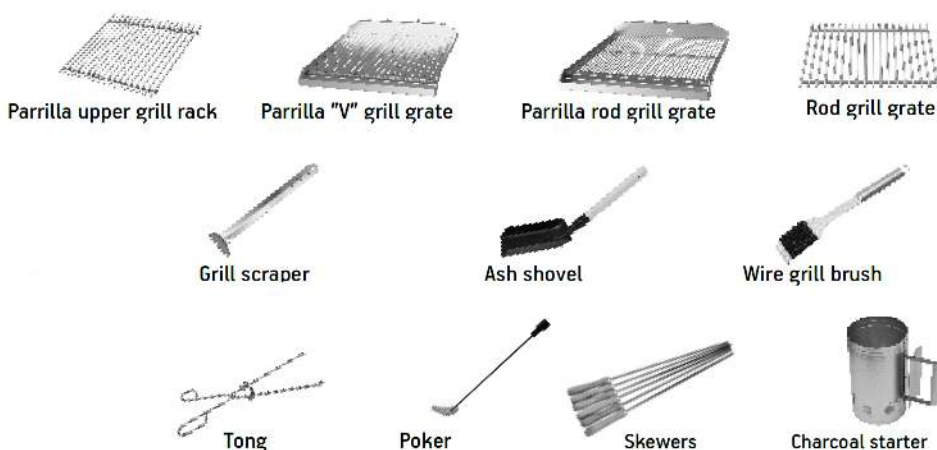

TECHNICAL DRAWINGS

Front view

Side view

Top view

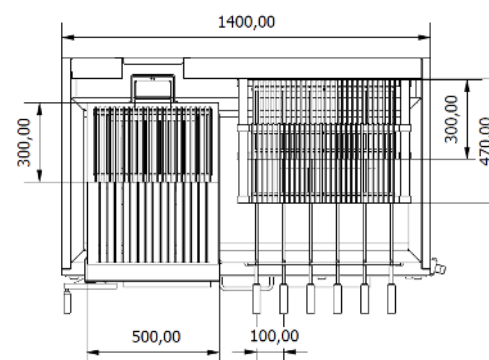
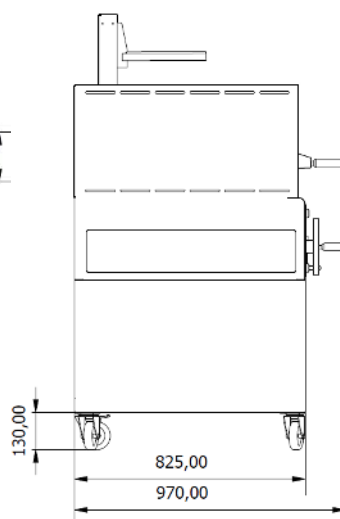
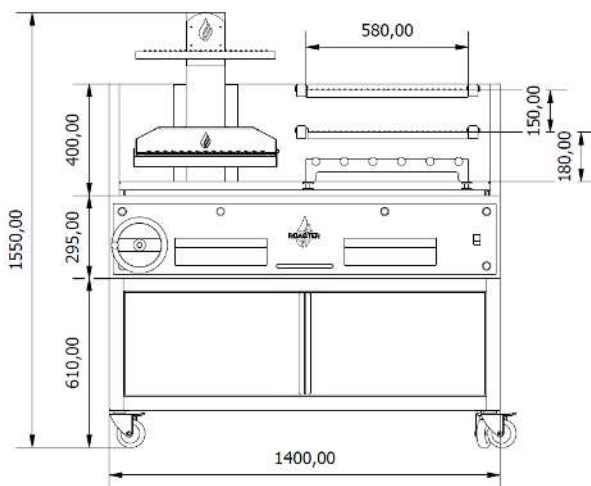

MAIN COMPONENTS

