

ROASTER CHARCOAL OVEN R53s



AVAILABLE COLORS



Inox door



Black door



Red door



Blue door

ACCESSORIES



Grill rack



Top GN tray



Tong



Poker



Grill scraper



Ash shovel



Wire grill brush



Clip tong for trays

TECHNICAL INFORMATION

Productivity +-	35 diners
Fire up time	30 min average
Charcoal daily consumption *	5 - 7 kg
Performance *	7 h
Broiling temperature	250°C to 350°C
Exhaust rate	1500m3/h
Heat Output	5 kw
Extraction Diameter Φ	180 mm

DIMENSIONS & WEIGHTS

Without packaging	785X477X995 mm
With packaging	930X680X1270 mm
Weight (NET)	180 kg
Weight (with packaging)	230 kg

INSTALLATION

Clearance with non-flammable equipment	100 mm
Clearance with flammable equipment	300 mm

*Depends on the charcoal quality

INCLUDED

Fire braker	Tong	Grill Scraper
2x Stainless Steel Grill Grates	Clip Tong	Ash Shovel
2x Top GN Trays	Wire Brush	Poker
Grease Collector	Ash Collector Drawer	Packaging



TECHNICAL DRAWINGS

Front view

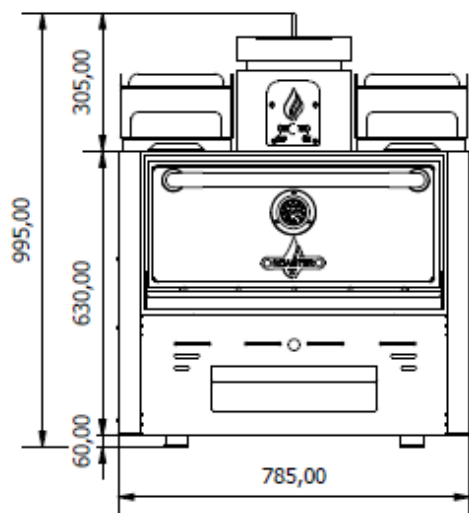

Side view

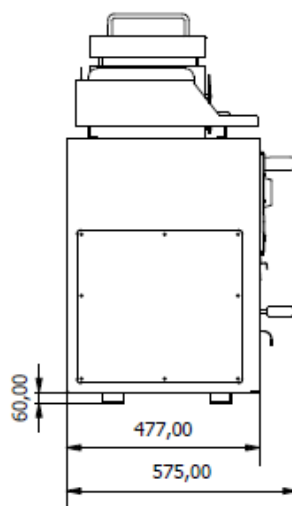

Dimensions with Open Door

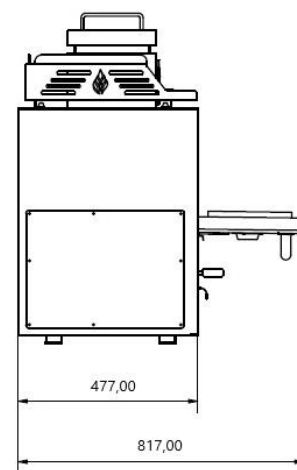

Top view

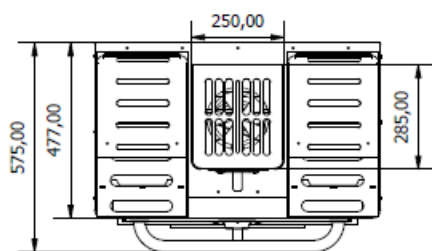

Roasting area

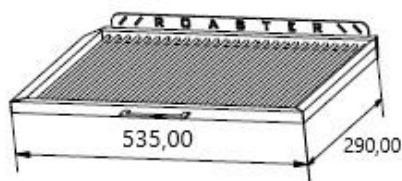

Gastronorm rack

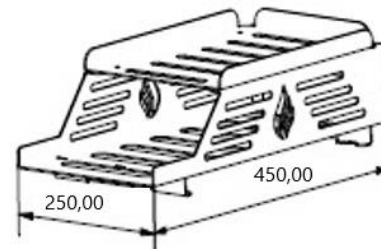

MAIN COMPONENTS

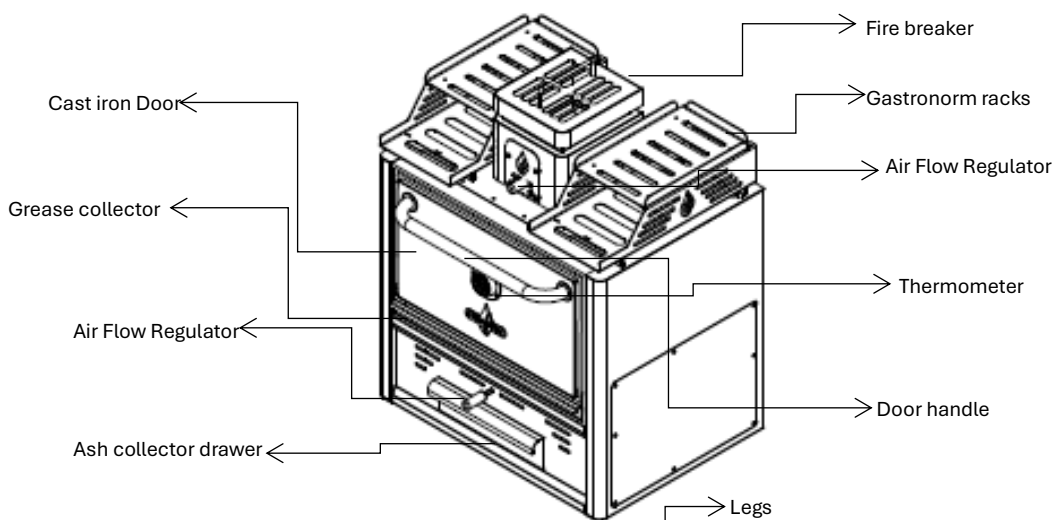

*Dimensions in mm

*The charcoal ovens are subject to technical and design changes without previous notice

