

**ROASTER CHARCOAL OVEN ROC53s**



**AVAILABLE COLORS**



Inox door



Black door



Red door



Blue door

**ACCESSORIES**



Grill rack



Top GN tray



Tong



Poker



Grill scraper



Ash shovel



Wire grill brush



Clip tong for trays

**CABINET OPTIONS**



Open Cabinet with one shelf



Cabinet with drawers

**TECHNICAL INFORMATION**

Productivity +/-	35 diners
Fire up time	30 min average
Charcoal daily consumption *	5 - 7 kg
Performance *	7 h
Broiling temperature	250°C to 350°C
Exhaust rate	1500m3/h
Heat Output	5 kw
Extraction Diameter Φ	180 mm

**DIMENSIONS & WEIGHTS**

Without packaging	785X477X1585 mm
With packaging	930X680X1790 mm
Weight (NET)	205 kg
Weight (with packaging)	272 kg

**INSTALLATION**

Clearance with non-flammable equipment	100 mm
Clearance with flammable equipment	300 mm

\*Depends on the charcoal quality

**INCLUDED**

Fire braker	Tong	Grill Scraper
2x Stainless Steel Grill Grates	Clip Tong	Ash Shovel
2x Top GN Trays	Wire Brush	Poker
Grease Collector	Ash Collector Drawer	Packaging



**TECHNICAL DRAWINGS**

Front view

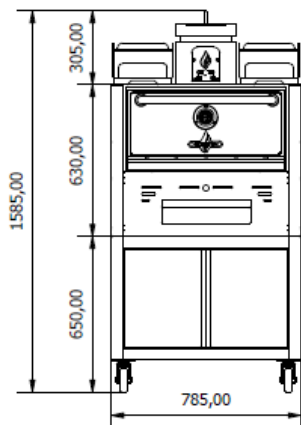

Side view

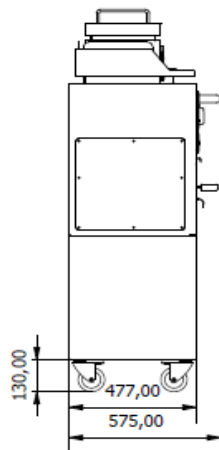

Dimensions with Open Door

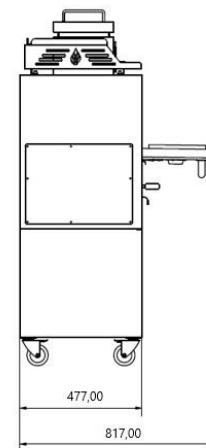

Top view

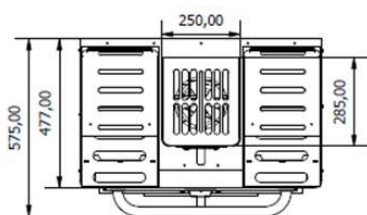

Roasting area

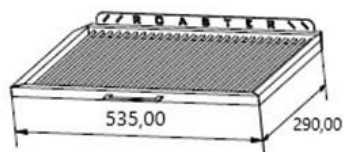

Gastronorm rack

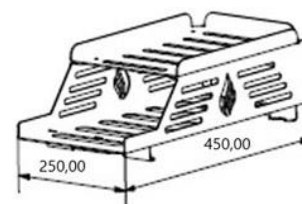

**MAIN COMPONENTS**

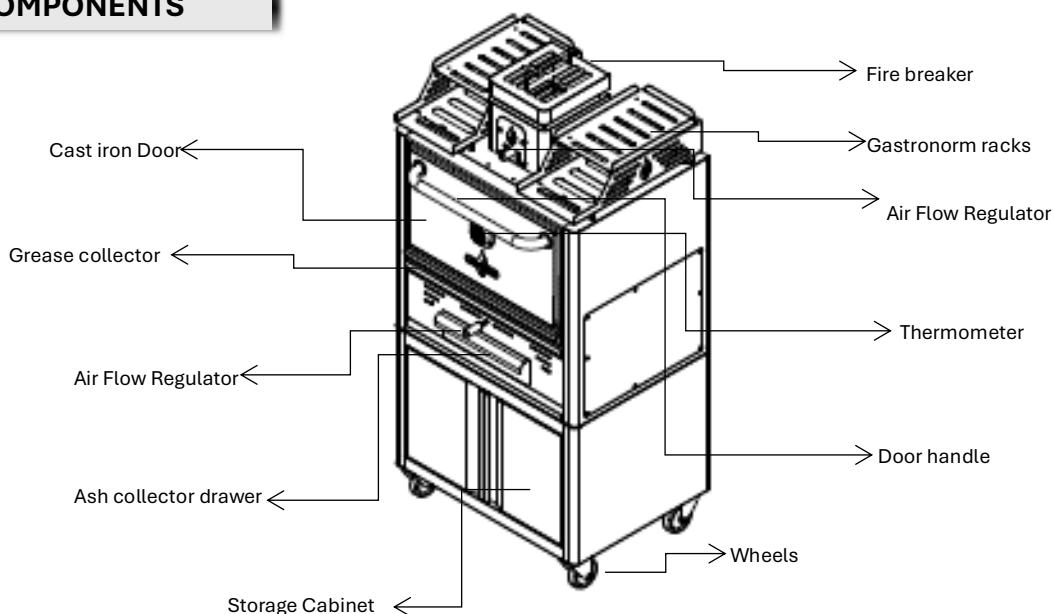

\*Dimensions in mm

\*The charcoal ovens are subject to technical and design changes without previous notice

