

ROASTER CHARCOAL OVEN ROC54



TECHNICAL INFORMATION

Productivity +/-	45 diners
Fire up time	30 min average
Charcoal daily consumption *	6 – 8 kg
Performance *	7 h
Broiling temperature	250°C to 350°C
Exhaust rate	1600 m3/h
Heat Output	6 kw
Extraction Diameter Φ	180 mm

DIMENSIONS & WEIGHTS

Without packaging	785X577X1685 mm
With packaging	930X780X1890 mm
Weight (NET)	263 kg
Weight (with packaging)	330 kg

AVAILABLE COLORS



Inox door



Black door



Red door



Blue door

INSTALLATION

Clearance with non-flammable equipment	100 mm
Clearance with flammable equipment	300 mm

*Depends on the charcoal quality

INCLUDED

Fire braker	Tong	Grill Scraper
2x Stainless Steel Grill Grates	Clip Tong	Ash Shovel
2x Top GN Trays	Wire Brush	Poker
Grease Collector	Ash Collector Drawer	Packaging

ACCESSORIES



Grill rack



Top GN tray



Tong



Poker



Grill scraper



Ash shovel



Wire grill brush



Clip tong for trays

CABINET OPTIONS



Open Cabinet with one shelf



Cabinet with drawers



TECHNICAL DRAWINGS

Front view

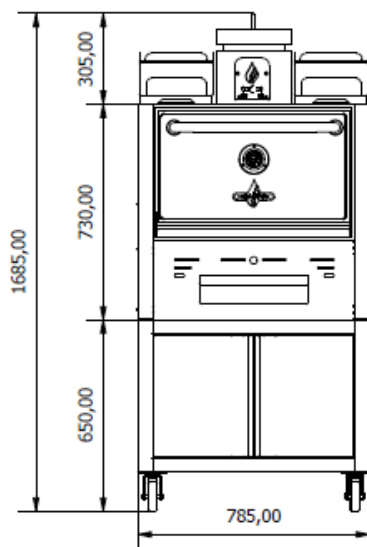

Side view

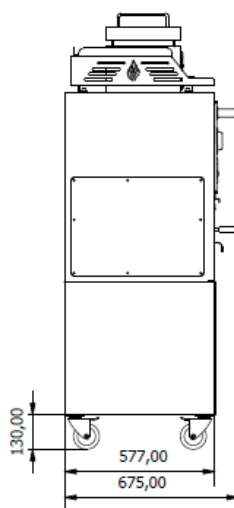

Dimensions with Open Door

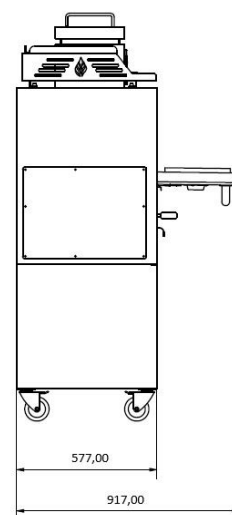

Top view

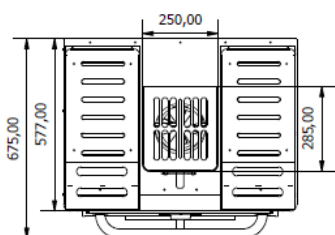

Roasting area

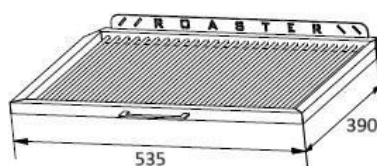

Gastronorm rack

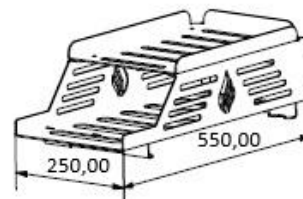

MAIN COMPONENTS

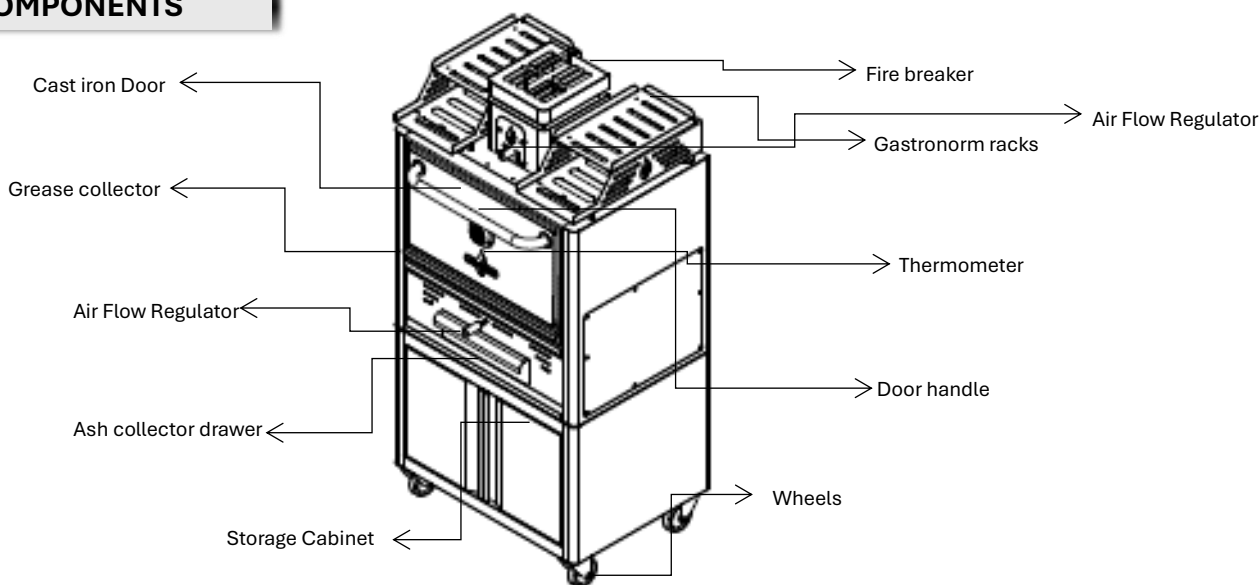

*Dimensions in mm

*The charcoal ovens are subject to technical and design changes without previous notice

