

**ROASTER CHARCOAL OVEN ROC56**



**AVAILABLE COLORS**



Inox door



Black door



Red door



Blue door

**ACCESSORIES**

**TECHNICAL INFORMATION**

Productivity +/-	75 diners
Fire up time	30 min average
Charcoal daily consumption *	22.04 – 26.45 lbs
Performance *	9 h
Broiling temperature	482°C to 350°C
Exhaust rate	2100 m3/h
Heat Output	6 kw
Extraction Diameter Φ	180 mm

**DIMENSIONS & WEIGHTS**

Without packaging	785X777X1685 mm
With packaging	930X980X1890 mm
Weight (NET)	312 kg
Weight (with packaging)	379 kg

**INSTALLATION**

Clearance with non-flammable equipment	100 mm
Clearance with flammable equipment	300 mm

\*Depends on the charcoal quality

**INCLUDED**

Fire braker	Tong	Grill Scraper
2x Stainless Steel Grill Grates	Clip Tong	Ash Shovel
2x Top GN Trays	Wire Brush	Poker
Grease Collector	Ash Collector Drawer	Packaging

**CABINET OPTIONS**



Open Cabinet with one shelf



Cabinet with drawers



**TECHNICAL DRAWINGS**

Front view

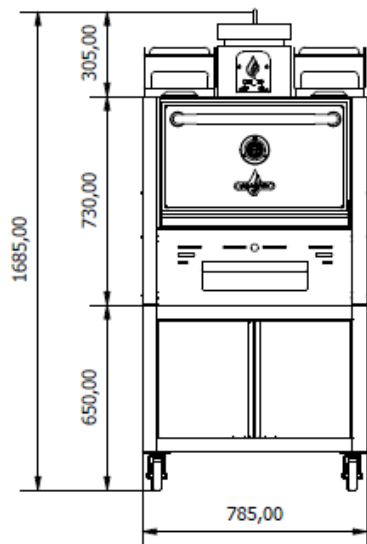

Side view

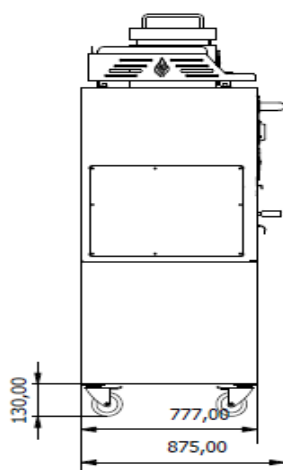

Dimensions with Open Door

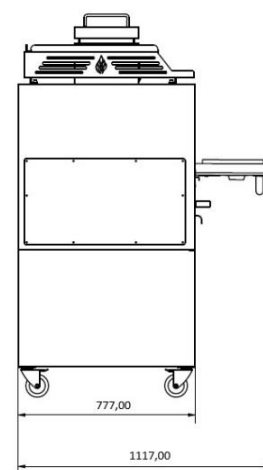

Top view

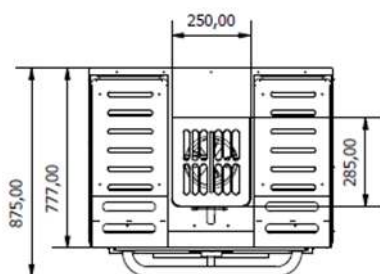

Roasting area

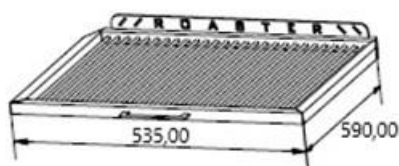

Gastronorm rack

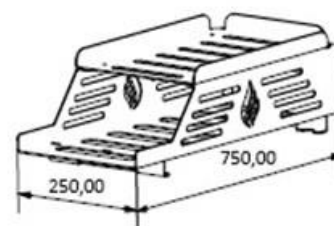

**MAIN COMPONENTS**

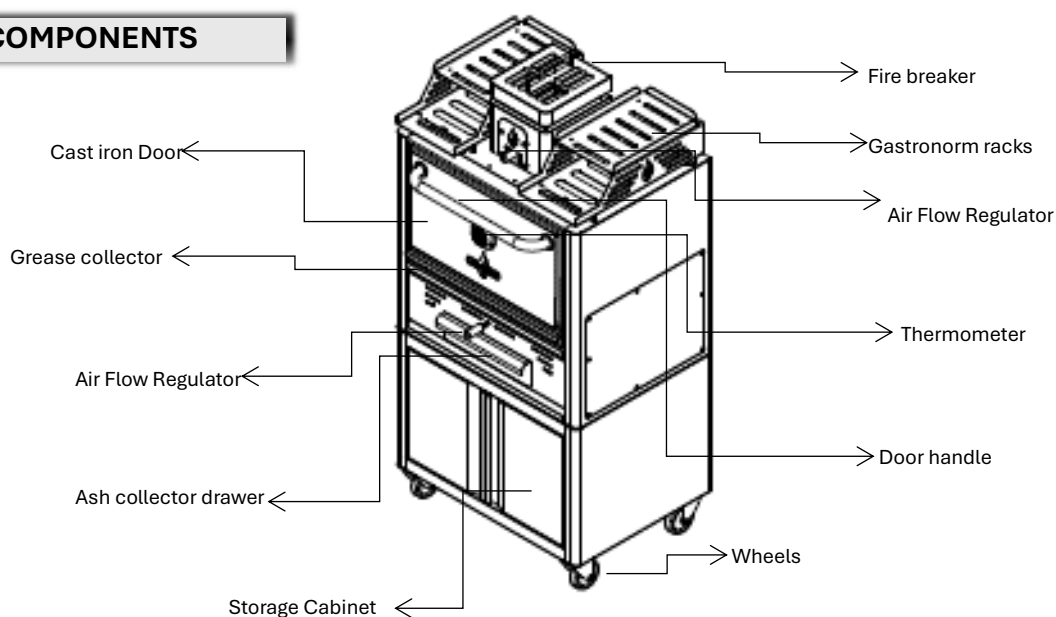

\*Dimensions in mm

\*The charcoal ovens are subject to technical and design changes without previous notice

