

ROASTER CHARCOAL OVEN ROC76



AVAILABLE COLORS



Inox door



Black door



Red door



Blue door

ACCESSORIES



Grill rack



Top GN tray



Tong



Poker



Grill scraper



Ash shovel



Wire grill brush



Clip tong for trays

CABINET OPTIONS



Open Cabinet with one shelf



Cabinet with drawers

TECHNICAL INFORMATION

Productivity +/-	110 diners
Fire up time	30 min average
Charcoal daily consumption *	15 – 17 kg
Performance *	9 h
Broiling temperature	250°C to 350°C
Exhaust rate	2500 m3/h
Heat Output	8 kw
Extraction Diameter Φ	180 mm

DIMENSIONS & WEIGHTS

Without packaging	985X777X1685 mm
With packaging	1130X980X1890 mm
Weight (NET)	390 kg
Weight (with packaging)	458 kg

INSTALLATION

Clearance with non-flammable equipment	100 mm
Clearance with flammable equipment	300 mm

*Depends on the charcoal quality

INCLUDED

Fire braker	Tong	Grill Scraper
2x Stainless Steel Grill Grates	Clip Tong	Ash Shovel
2x Top GN Trays	Wire Brush	Poker
Grease Collector	Ash Collector Drawer	Packaging



TECHNICAL DRAWINGS

Front view

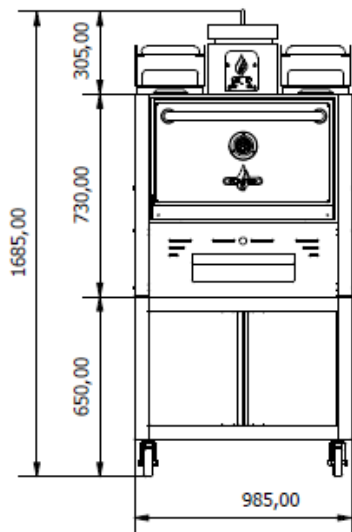

Side view

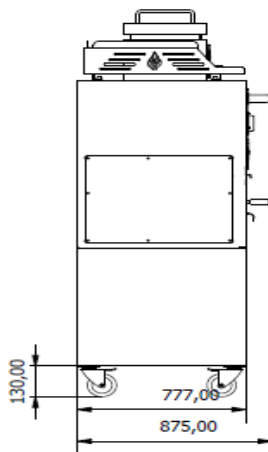

Dimensions with Open Door

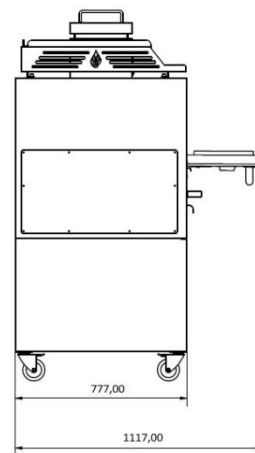

Top view

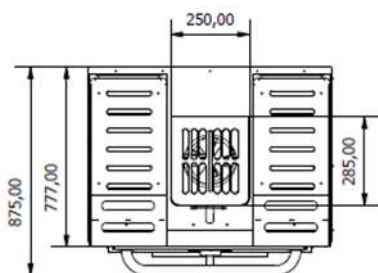

Roasting area

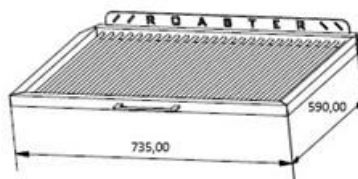

Gastronorm rack

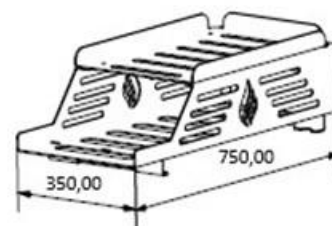

MAIN COMPONENTS

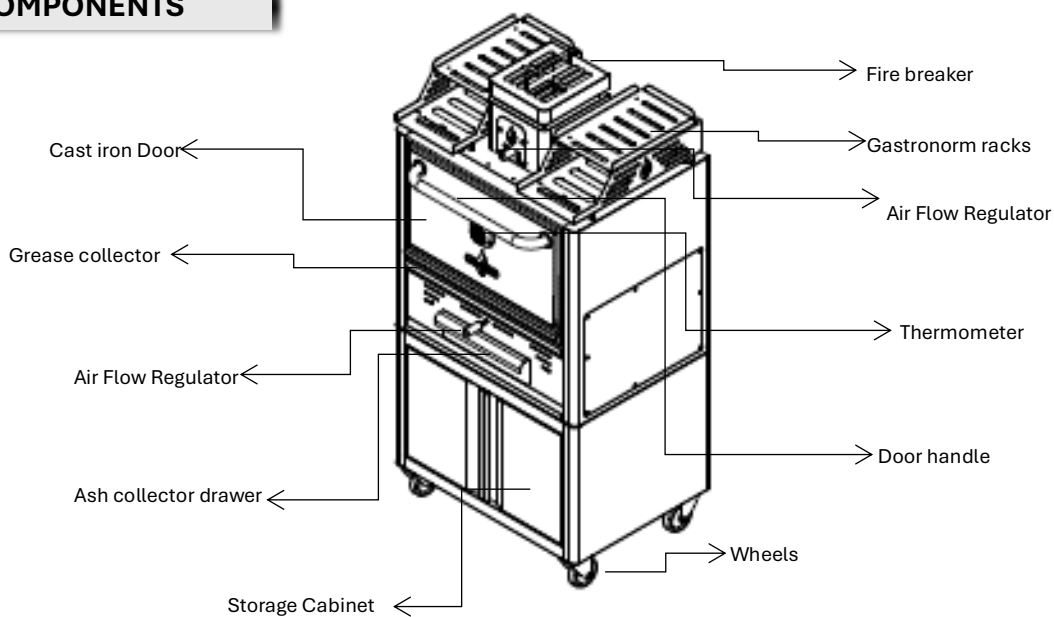

*Dimensions in mm

*The charcoal ovens are subject to technical and design changes without previous notice

